

THERMAL MANAGEMENT

HEATING

Heating resistors without fan

Reference:
RC15SV

Technical data:

Voltage:	110-250 V AC/DC
Heating capacity:	15 W
Inrush current max.:	1,5 A
Axial fan airflow:	-
Heating element:	PTC resistor, self regulating and temperature limiting
Heater body:	Extruded aluminium profile, anodised
Connection casing:	Plastic according to UL94 V0, black
Temperature safety cut-out:	-
Surface temperature:	-
Operating/Storage temperature:	-45 °C / +70 °C
Electrical connection:	3 pressure clamps for stranded wire 0.5-1.5 mm ² (with wire end ferrule) and rigid wire 0.5-2.5 mm ²
Dimensions:	(L=70)x70x60 mm
Weight:	0,14
Degree of protection:	IP20
Protection class:	Clase I (Earthed)
Mounting:	Clip for 35 mm DIN rail
Fitting position:	Vertical airflow
Service life:	-



THERMAL MANAGEMENT

HEATING

Heating resistors without fan

Reference:
RC15SV

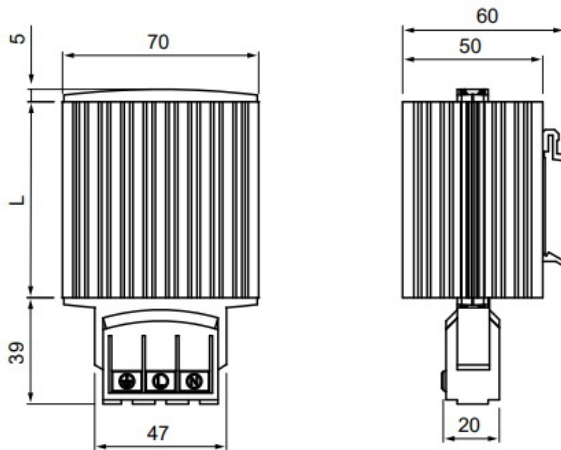

Codes:

EAN: 8431044250946
Customs tariff number: 85.38.10.00
ETIM 8.0: EC000737

Product end of life:

Product concerned in the WEEE regulations.

Supply:

Supplied in individual cardboard packaging.

Certificates and standards:

Certificates: CE

